

DATA SHEET

Product Name High Quality Anti-Sulfurized Automotive Thick Film Chip Resistors

Part Name NS Series

File No. SMD-SP -022

Uniroyal Electronics Global Co., Ltd.

88#, Longteng Road, Economic & Technical Development Zone, Kunshan, Jiangsu, China

Tel +86 512 5763 1411 / 22 /33

Email marketing@uni-royal.cn

Manufacture Plant Uniroyal Electronics Industry Co., Ltd.

Aeon Technology Corporation

Royal Electronic Factory (Thailand) Co., Ltd.

Royal Technology (Thailand) Co., Ltd.

1. Scope

- 1.1 This datasheet is the characteristics of High Quality Anti-Sulfurized Automotive Thick Film Chip Resistors manufactured by UNI-ROYAL.
- 1.2 Superior Anti-Sulfurized
- 1.3 High power
- 1.4 Suitable for reflow & wave soldering
- 1.5 AEC-Q200 qualified
- 1.6 Compliant with RoHS directive.
- 1.7 Halogen free requirement.

2. Part No. System

Part No. includes 14 codes shown as below:

- 2.1 1st~4th codes: Part name. E.g.: NS01,NS02,NS03,NS05,NS06,NS07,NS10,NS12
- 2.2 5th~6th codes: Power rating.

E.g.: W=Normal Size “1~G” = “1~16”

Wattage	3/4	1/3	1/4	1/8	1/10	1/16	1/20	1
Normal Size	07	W3	W4	W8	WA	WG	WM	1W

If power rating is equal or lower than 1 watt, 5th code would be “W” and 6th code would be a number or letter.

E.g.: WA=1/10W W2=1/2W

- 2.3 7th code: Tolerance. E.g.: F=±1% J=±5%

- 2.4 8th~11th codes: Resistance Value.

2.4.1 If value belongs to standard value of E-24 series, the 8th code is zero, 9th~10th codes are the significant figures of resistance value, and the 11th code is the power of ten.

2.4.2 If value belongs to standard value of E-96 series, the 8th~10th codes are the significant figures of resistance value, and the 11th code is the power of ten.

2.4.3 11th codes listed as following:

0=10⁰ 1=10¹ 2=10² 3=10³ 4=10⁴ 5=10⁵ 6=10⁶ J=10⁻¹ K=10⁻² L=10⁻³ M=10⁻⁴

- 2.5 12th~14th codes.

2.5.1 12th code: Packaging Type. E.g.: C=Bulk T=Tape/Reel

2.5.2 13th code: Standard Packing Quantity.

4=4,000pcs 5=5,000pcs C=10,000pcs E=15,000pcs

2.5.3 14th code: Special features.

E = Environmental Protection, Lead Free, or Standard type.

3. Ordering Procedure

(Example: NS05 1/8W ±5% 1.2Ω T/R-5000)

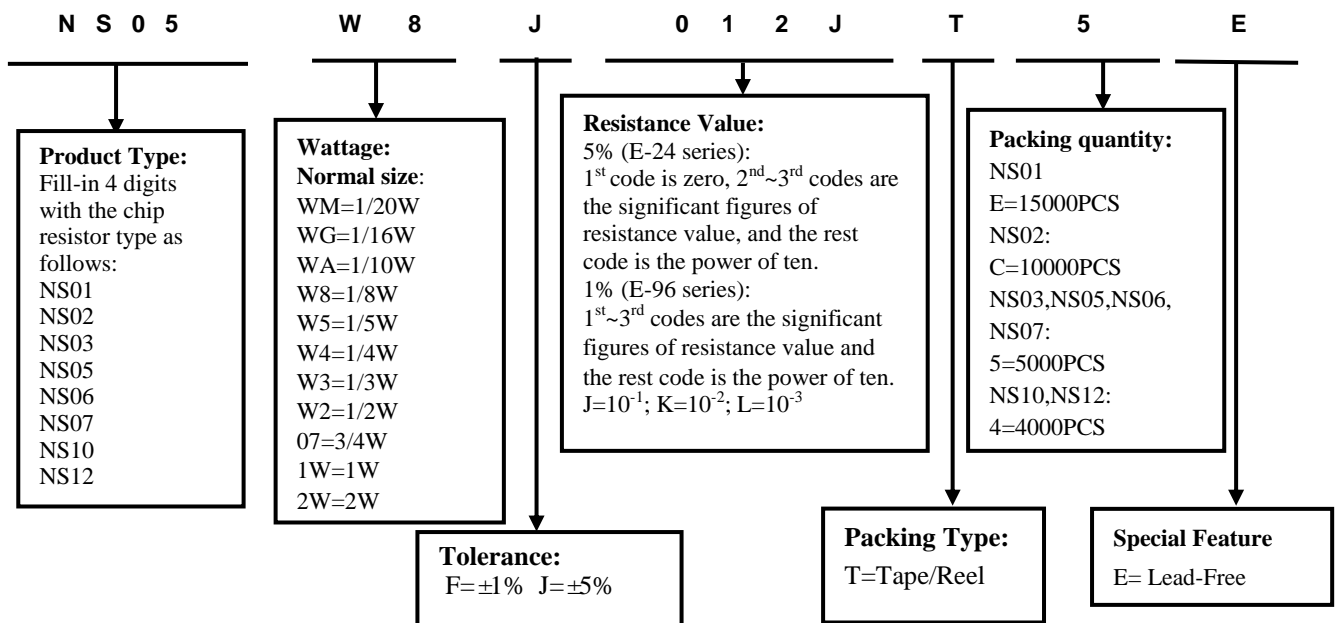

4. Marking:

4.1 For NS01, NS02 size. Due to the very small size of the resistor's body, there is no marking on the body.



4.2 Normally, the marking of 0Ω NS03, 0Ω NS05, 0Ω NS06, 0Ω NS07, 0Ω NS10, 0Ω NS12 resistors as following



0 → 0

4.3 ±5% tolerance products (E-24 series):
3 codes.

1st~2nd codes are the significant figures of resistance value, and the rest code is the power of ten.



333 → 33KΩ

4.4 ±1% tolerance products (E-96 series):
4 codes.

1st~3rd codes are the significant figures of resistance value, and the rest code is the power of ten.

Letter "R" in mark means decimal point.



2701 → 2.7KΩ

4.5 Standard E-96 series values of 0603 ≤1% : due to the small size of the resistor's body, 3 digits marking will be used to indicate the accurate resistance value by using the following multiplier & resistance code.

Multiplier Code (for 0603 ≤±1% marking)

Code	A	B	C	D	E	F	G	H	X	Y	Z
Multiplier	10 ⁰	10 ¹	10 ²	10 ³	10 ⁴	10 ⁵	10 ⁶	10 ⁷	10 ⁻¹	10 ⁻²	10 ⁻³

Standard E-96 series Resistance Value code (for 0603 ≤±1% marking)

Value	Code	Value	Code	Value	Code	Value	Code
100	01	178	25	316	49	562	73
102	02	182	26	324	50	576	74
105	03	187	27	332	51	590	75
107	04	191	28	340	52	604	76
110	05	196	29	348	53	619	77
113	06	200	30	357	54	634	78
115	07	205	31	365	55	649	79
118	08	210	32	374	56	665	80
121	09	215	33	383	57	681	81
124	10	221	34	392	58	698	82
127	11	226	35	402	59	715	83
130	12	232	36	412	60	732	84
133	13	237	37	422	61	750	85
137	14	243	38	432	62	768	86
140	15	249	39	442	63	787	87
143	16	255	40	453	64	806	88
147	17	261	41	464	65	825	89
150	18	267	42	475	66	845	90
154	19	274	43	487	67	866	91
158	20	280	44	499	68	887	92
162	21	287	45	511	69	909	93
165	22	294	46	523	70	931	94
169	23	301	47	536	71	953	95
174	24	309	48	549	72	976	96

So the resistance value are marked as the following examples



$$1.96K\Omega = 196 \times 10^1 \Omega = 29B$$



$$12.4\Omega = 124 \times 10^{-1} \Omega = 10X$$

4.6 Standard E-24 and not belong to E-96 series values ($\leq \pm 1\%$) of 0603 size: the marking is the same as 5% tolerance but marking as underline.



$$\underline{333} = 33K\Omega$$



$$\underline{680} = 68\Omega$$

5. Dimension

Type	Dimension(mm)				
	L	W	H	A	B
NS01(0201)	0.60±0.03	0.30±0.03	0.23±0.03	0.12±0.05	0.15±0.05
NS02(0402)	1.00±0.10	0.50±0.05	0.35±0.05	0.20±0.10	0.25±0.10
NS03(0603)	1.60±0.10	0.80±0.10	0.45±0.10	0.30±0.20	0.30±0.20
NS05(0805)	2.00±0.15	1.25+0.15/-0.10	0.55±0.10	0.40±0.20	0.40±0.20
NS06(1206)	3.10±0.15	1.55+0.15/-0.10	0.55±0.10	0.45±0.20	0.45±0.20
NS07(1210)	3.10±0.10	2.60±0.20	0.55±0.10	0.50±0.25	0.50±0.20
NS10(2010)	5.00±0.10	2.50±0.20	0.55±0.10	0.60±0.25	0.50±0.20
NS12(2512)	6.35±0.10	3.20±0.20	0.55±0.10	0.60±0.25	0.50±0.20

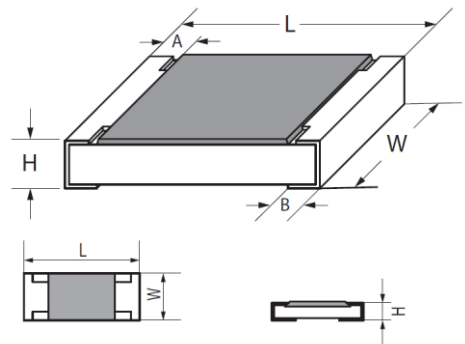

6. Resistance Range

Type	Power Rating (P_t)		Resistance Range	
	t=70°C	t=125°C	1.0%	5.0%
NS01	1/20W	/	1Ω-10MΩ	1Ω-10MΩ
NS02	1/10W	1/16W	1Ω-10MΩ	1Ω-10MΩ
NS03	1/5W	1/10W	1Ω-10MΩ	1Ω-10MΩ
NS05	1/3W	1/8W	1Ω-10MΩ	1Ω-10MΩ
NS06	1/2W	1/4W	1Ω-10MΩ	1Ω-10MΩ
NS07	3/4W	1/3W	1Ω-10MΩ	1Ω-10MΩ
NS10	1W	3/4W	1Ω-10MΩ	1Ω-10MΩ
NS12	2W	1W	1Ω-10MΩ	1Ω-10MΩ

7. Ratings

Type	Max. Working Voltage	Max. Overload Voltage	Dielectric withstanding Voltage	Resistance Value of Jumper	Rated Current of Jumper	Max. Overload Current of Jumper	Operating Temperature
NS01	25V	50V	/	<50mΩ	0.5A	1A	-55°C~155°C
NS02	50V	100V	100V	<50mΩ	1A	2A	-55°C~155°C
NS03	75V	150V	300V	<50mΩ	1A	2A	-55°C~155°C
NS05	150V	300V	500V	<50mΩ	2A	5A	-55°C~155°C
NS06	200V	400V	500V	<50mΩ	2A	10A	-55°C~155°C
NS07	200V	500V	500V	<50mΩ	2A	10A	-55°C~155°C
NS10	200V	500V	500V	<50mΩ	2A	10A	-55°C~155°C
NS12	200V	500V	500V	<50mΩ	2A	10A	-55°C~155°C

8. Soldering pad size recommended

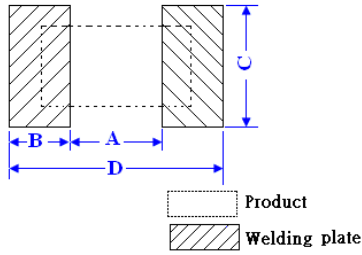

Type	Dimension(mm)			
	A	B	C	D
NS01	0.3±0.05	0.35±0.05	0.4±0.05	1.0±0.05
NS02	0.5±0.05	0.5±0.05	0.6±0.05	1.5±0.05
NS03	0.8±0.05	0.8±0.05	0.9±0.05	2.4±0.05
NS05	1.0±0.1	1±0.1	1.4±0.1	3±0.1
NS06	2.0±0.1	1.1±0.1	1.8±0.1	4.2±0.1
NS07	2.0±0.1	1.1±0.1	2.9±0.1	4.2±0.1
NS10	3.6±0.1	1.4±0.1	3±0.1	6.4±0.1
NS12	4.9±0.1	1.35±0.1	3.7±0.1	7.6±0.1

9. Derating Curve

Power rating will change based on continuous load at ambient temperature from -55 to 155°C.

For resistors operated at an ambient temperature over t °C, the power shall be derated in accordance with the above derating curve.

(P₇₀、P₁₂₅、t specifically refer to 6.0)

Voltage rating:

Resistors shall have a rated direct-current (DC) continuous working voltage or an approximate sine-wave root-mean-square (RMS) alternating-current (AC) continuous working voltage at commercial-line frequency and waveform corresponding to the power rating, as determined from the following formula:

$$RCWV = \sqrt{P \times R}$$

Remark: RCWV: Rating Continuous Working Voltage (Volt.) P: power rating (Watt) R: nominal resistance (Ω)

In no case shall the rated DC or RMS AC continuous working voltage be greater than the applicable maximum value.

The overload voltage is 2.5 times RCWV or Max. Overload voltage whichever is lower.

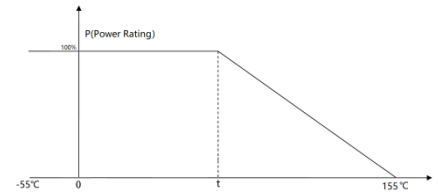

10. Structure

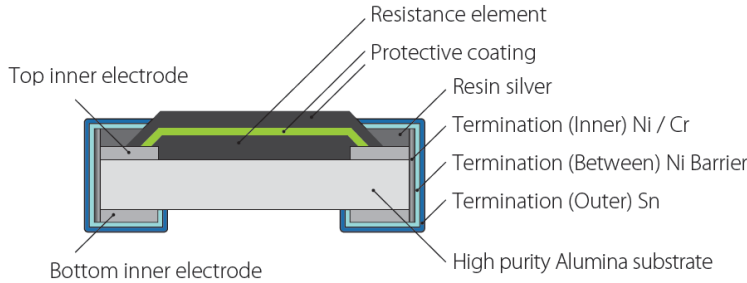

11. One-pulse Limiting Electric Power

11.1 Curve of Pulse Duration :

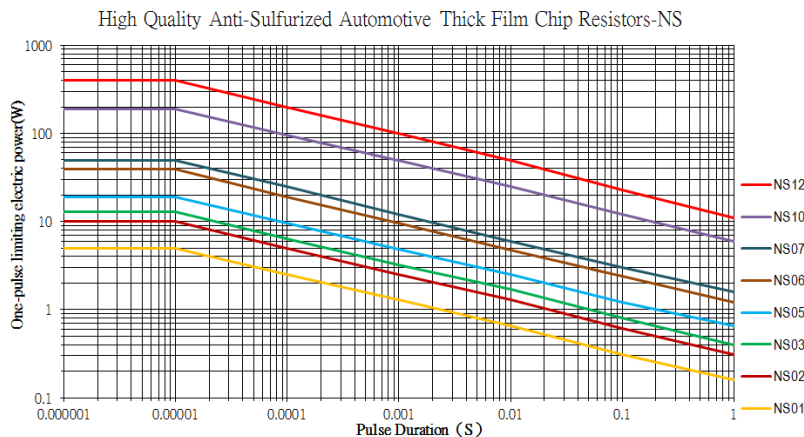

11.2 Pulse Voltage Limit :

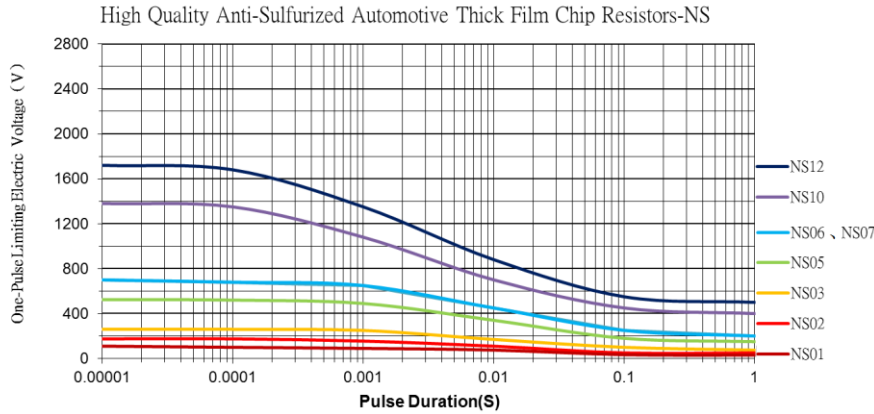

12. Performance Specification

Characteristic	Limits		Ref. Standards	Test Method
	Resistor	0 Ω		
Operational life	±5%: ±(3.0%+0.1Ω) ±1%: ±(1.0%+0.1Ω)	<100mΩ	MIL-STD-202	70°C power , at RCWV or Max .Working Voltage whichever less, 1000h (1.5 hours “ON”, 0.5 hour “OFF”). Measurement at 24±4hours after test conclusion. Apply to rate current for 0 Ω
Electrical Characterization	NS01: 1Ω≤R≤10Ω : -100~+350 ppm/ °C > 10Ω : ±200 ppm/ °C NS02~NS12: 10Ω<R≤10 Ω: ±200 ppm/°C > 10Ω: ±100 ppm/°C	NA	User Spec	Parametrically test per lot and sample size requirements, summary to show Min, Max, Mean and Standard deviation at room as well as Min and Max operating temperatures.
Short-time overload	±1%: ±(1.0%+0.05Ω) ±5%: ±(2.0%+0.05Ω)	<50mΩ	JIS-C-5201	4.13 Permanent resistance change after the application of a potential of 2.5 times RCWV or Max. Overload Voltage whichever less for 5 seconds.. Apply max Overload current for 0Ω
External Visual	No Mechanical Pamage		MIL-STD-883 Method 2009	Electrical test not required.Inspect device construction, marking and workmanship
Physical Dimension	Reference 5. Dimension Standards		JESD22 MH Method JB-100	Verify physical dimensions to the applicable device detail specification. Note: User(s) and Suppliers spec. Electrical test not required.
Resistance to Solvent	Marking Unsmearred		MIL-STD-202 Method 215	Note: Add Aqueous wash chemical – OKEM Clean or equivalent. Do not use banned solvents.
Terminal Strength	Not broken		JIS-C-6429	0201:2N,0402:5N; others:17.7N, 60± 1 seconds.
High Temperature Exposure (Storage)	±(1.0%+0.1Ω)	<100mΩ	MIL-STD-202 Method 108	1000hrs. @T=155°C.Unpowered. Measurement at 24±2 hours after test conclusion. Apply to rate current for 0 Ω
Temperature Cycling	±(1.0%+0.1Ω)	<100mΩ	JESD22 Method JA-104	1000 Cycles (-55°C to +155°C). Measurement at 24±2 hours after test conclusion. Apply to rate current for 0 Ω
Biased Humidity	±5%: ±(3.0%+0.05Ω) ±1%: ±(1.0%+0.05Ω)	<100mΩ	MIL-STD-202 Method 103	1000 hours 85°C,85%RH. Note: Specified conditions: 10% of operating power. Measurement at 24±2 hours after test conclusion. Apply to rate current for 0 Ω
Mechanical Shock	±(1.0%+0.1Ω)	<50mΩ	MIL-STD-202 Method 213	Wave Form: Tolerance for half sine shock pulse. Peak value is 100g’s. Normal duration (D) is 6ms,velocity 12.3ft/s 100Hz.

Vibration	$\pm(1.0\%+0.05\Omega)$	<50m Ω	MIL-STD-202 Method 204	5g's for 20 min., 12cycle each of 3 orientations. Note: Use 8"*5"PCB. 031" thick 7 secure points on one long side and 2 secure points at corners of opposite sides. Parts mounted within 2' from any secure point. Test from 10-2000Hz.
ESD	$\pm(3.0\%+0.05\Omega)$	<50m Ω	AEC-Q200-002	With the electrometer in direct contact with the discharge tip, verify the voltage setting at levels of $\pm 500V, \pm 1KV, \pm 2KV, \pm 4KV, \pm 8KV$, The electrometer reading shall be within $\pm 10\%$ for voltages from 500V to $\leq 800V$.
Solderability	Coverage must be over 95%.		J-STD-020E	For both leaded & SMD. Electrical test not required. Magnification 50X. Conditions: a) Method B 4hrs at 155°C dry heat, the dip in bath with 245°C, 5s. b) Method D: at 260°C, 30 \pm 0.5s.
Flammability	No ignition of the tissue paper or scorching or the pinewood board		UL-94	V-0 or V-1 are acceptable. Electrical test not required.
Board Flex	$\pm(1.0\%+0.05\Omega)$	<50m Ω	JIS-C-6429	Bending 3mm(NS01-NS05)/2mm(NS06-NS12) for 60 \pm 5sec Apply to rate current for 0 Ω
Flame Retardance	No flame		AEC-Q200-001	Temperature sensing at 500°C, Voltage power subjected to 32VDC current clamped up to 500VDC and decreased in 1.0VDC/hour.
Resistance to Soldering Heat	$\pm(1.0\%+0.05\Omega)$	<50m Ω	MIL-STD-202 Method 210	Condition B No per-heat of samples. Note: Single Wave Solder-Procedure 2 for SMD and Procedure 1 for Leaded with solder within 1.5mm of device body. Apply to rate current for 0 Ω
Sulfuration test	$\pm(1.0\%+0.05\Omega)$	<100m Ω	ASTMB-809-55	Sulfur (Saturated vapor) : Test temp.: 90°C Relative humidity: 74 \pm 7%RH Test time: 1000h
	$\pm(5.0\%+0.05\Omega)$	<100m Ω	/	Soaked in industrial oil with sulfur substance 3.5% contained 105°C \pm 3°C, 500H

13. Soldering Condition

(This is for recommendation, please customer perform adjustment according to actual application)

13.1 Recommend Reflow Soldering Profile : (solder : Sn96.5 / Ag3 / Cu0.5)

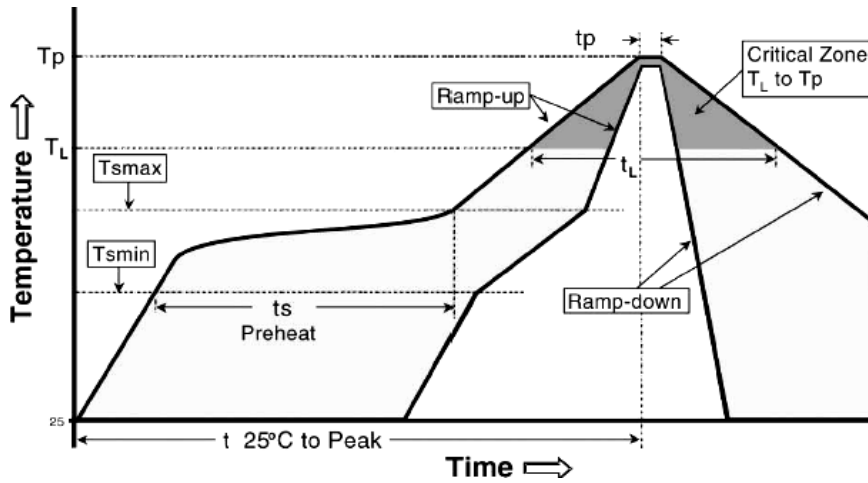

Profile Feature	Lead (Pb)-Free solder
Preheat: Temperature Min (T_{smin}) Temperature Max (T_{smax}) Time (T_{smin} to T_{smax}) (t_s)	150°C 200°C 60 -120 seconds
Average ramp-up rate: (T_{smax} to T_p)	3°C / second max.
Time maintained above : Temperature (T_L) Time (t_L)	217°C 60-150 seconds
Peak Temperature (T_p)	260°C
Time within $+0$ -5 °C of actual peak Temperature (t_p) ²	10 seconds
Ramp-down Rate	6°C/second max.
Time 25°C to Peak Temperature	8minutes max.

Allowed Re-flow times : 2 times

Remark : To avoid discoloration phenomena of chip on terminal electrodes, please use N2 Re-flow furnace .

13.2 Recommend Wave Soldering Profile : (Apply to 0603 and above size)

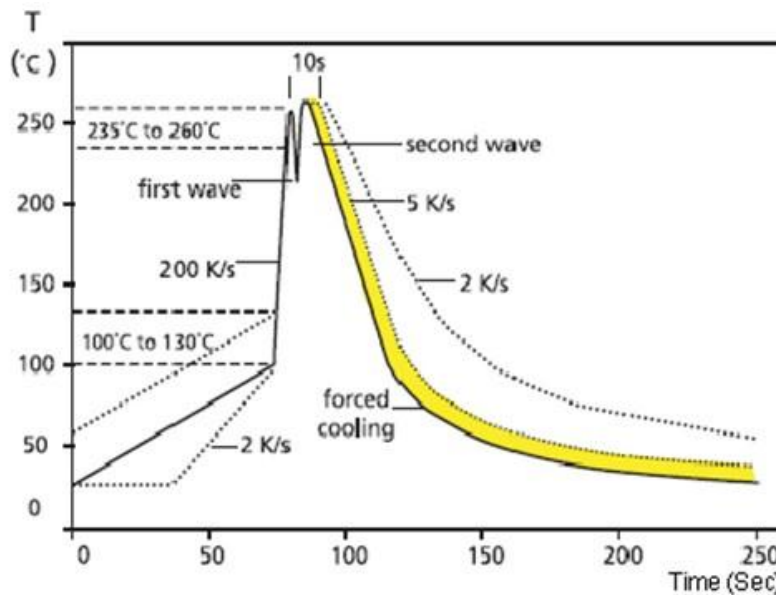

14. Packing of Surface Mount Resistors

14.1 Dimension of Paper Taping :(Unit: mm)

Type	A	B	C ±0.05	$\Phi D_{-0}^{+0.1}$	E ±0.1	F ±0.05	G ±0.1	W ±0.2	T
NS01	0.40±0.05	0.70±0.05	2.0	1.5	1.75	3.50	4.0	8.0	0.42±0.1
NS02	0.65 ±0.1	1.2±0.1	2.0	1.5	1.75	3.5	4.0	8.0	0.42±0.05

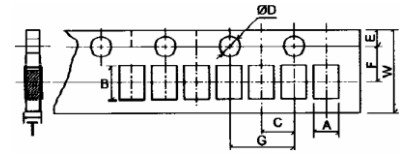

Type	A ±0.2	B ±0.2	C ±0.05	$\Phi D_{-0}^{+0.1}$	E ±0.1	F ±0.05	G ±0.1	W ±0.2	T ±0.1
NS03	1.10	1.90	2.0	1.5	1.75	3.5	4.0	8.0	0.67
NS05	1.65	2.40	2.0	1.5	1.75	3.5	4.0	8.0	0.81
NS06	2.00	3.60	2.0	1.5	1.75	3.5	4.0	8.0	0.81
NS07	2.80	3.50	2.0	1.5	1.75	3.5	4.0	8.0	0.75

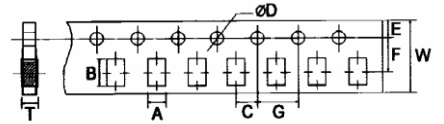

14.2 Dimension of plastic taping: (Unit: mm)

Type	A ±0.2	B ±0.2	C ±0.05	$\Phi D_{-0}^{+0.1}$	$\Phi D_{-0}^{+0.25}$	E ±0.1	F ±0.05	G ±0.1	W ±0.2	T ±0.1
NS10	2.90	5.60	2.00	1.50	1.50	1.75	5.50	4.00	12.00	1.00
NS12	3.50	6.70	2.00	1.50	1.50	1.75	5.50	4.00	12.00	1.00

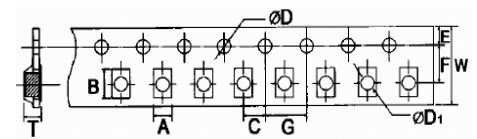

14.3 Dimension of Reel : (Unit: mm)

Type	Taping	Qty/Reel	A ±0.5	B ±0.5	C ±0.5	D ±1	M ±2	W ±1
NS01	Paper	15,000pcs	2.0	13.0	21.0	60.0	178	10
NS02	Paper	10,000pcs	2.0	13.0	21.0	60.0	178	10
NS03	Paper	5,000pcs	2.0	13.0	21.0	60.0	178	10
NS05	Paper	5,000pcs	2.0	13.0	21.0	60.0	178	10
NS06	Paper	5,000pcs	2.0	13.0	21.0	60.0	178	10
NS07	Paper	5,000pcs	2.0	13.0	21.0	60.0	178	10
NS10	Embossed	4,000pcs	2.0	13.0	21.0	60.0	178	13.8
NS12	Embossed	4,000pcs	2.0	13.0	21.0	60.0	178	13.8

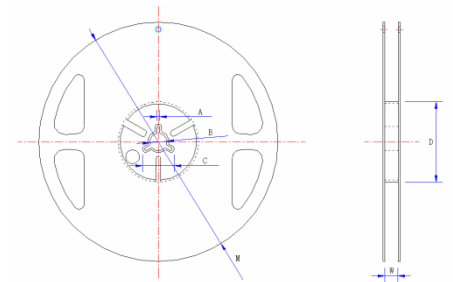

15. Note

15.1. UNI-ROYAL recommend products store in warehouse with temperature between 15 to 35°C under humidity between 25 to 75%RH.

Even under storage conditions recommended above, solder ability of products will be degraded stored over 1 year old.

15.2. Cartons must be placed in correct direction which indicated on carton, otherwise the reel or wire will be deformed.

15.3. Storage conditions as below are inappropriate:

- a. Stored in high electrostatic environment
- b. Stored in direct sunshine, rain, snow or condensation.

15.4 This product is used for automotive electronics. UNI-ROYAL will not be responsible for any damage, expense or loss caused by the use of this specification in any special environment. This series of products are suitable for automotive electronics applications, as shown below, If there are other applications, you need to confirm with UNI-ROYAL whether they are applicable:

- a. Control unit for information, entertainment, navigation, audio;
- b. Control unit for comfortable doors, windows, seat;
- c. Control unit for internal lighting.

16. Record

Version	Description	Page	Date	Amended by	Checked by
1	First version	1~8	Mar.20, 2018	Haiyan Chen	Nana Chen
2	Modify NS01 packing quantity	8	Jun.06, 2018	Haiyan Chen	Nana Chen
3	1.Modify product name 2. Modify characteristic	1~8	Feb.16, 2019	Haiyan Chen	Yuhua Xu
4	Experimental method and standard for adding vulcanization	6	Mar.05, 2019	Haiyan Chen	Yuhua Xu
5	1.Modify the reflow curve and add the wave soldering curve 2. Notes for improvement	6~7 8	Apr.30, 2020	Haiyan Chen	Yuhua Xu
6	1.Add the Power Rating at 70°C for NS02~NS12 2. Update the Derating Curve	4	Oct.14, 2021	Song Nie	Haiyan Chen
7	1.Modify the Performance Specification 2.Delete NS01 Structure 3.Add the 0603 marking	5~6	Sep.10, 2022	Haiyan Chen	Yuhua Xu
8	1.Cancel 125°C power 2.Modify the Derating Curve 2.Modify the Curve of Pulse Duration 3.Add the Pulse Voltage Limit	4 5 5 6	Dec.15, 2023	Haiyan Chen	Yuhua Xu
9	1. Restore the original 125°C power 2. Restore the original derating curve	4 5	Apr.08, 2024	Haiyan Chen	Yuhua Xu

© Uniroyal Electronics Global Co., Ltd. All rights reserved. Specification herein will be changed at any time without prior notice