



**UNI-ROYAL**  
厚聲集團

# DATA SHEET

**Product Name** High Quality Thin Film Chip Resistor

---

**Part Name** TA Series

**File No.** SMD-SP-031

## **Uniroyal Electronics Global Co., Ltd.**

88#, Longteng Road, Economic & Technical Development Zone, Kunshan, Jiangsu, China

Tel +86 512 5763 1411 / 22 /33

Email [marketing@uni-royal.cn](mailto:marketing@uni-royal.cn)

Manufacture Plant Uniroyal Electronics Industry Co., Ltd.

Aeon Technology Corporation

Royal Electronic Factory (Thailand) Co., Ltd.

Royal Technology (Thailand) Co., Ltd.

## 1. Scope

- 1.1. This datasheet is the characteristics of High Quality Thin Film Chip Resistor manufactured by UNI-ROYAL.
- 1.2. Tolerance to  $\pm 0.1\%$
- 1.3. Low TCR to  $\pm 10$  ppm/ $^{\circ}\text{C}$
- 1.4. Halogen free and lead free
- 1.5. RoHS compliant
- 1.6. Meet AEC-Q200 test requirements

## 2. Part No. System

Part No. includes 14 codes shown as below:

2.1 1<sup>st</sup>~4<sup>th</sup> codes: Part name. E.g.: TA01,TA02,TA03,TA05,TA06,TA07,TA10,TA12

2.2 5<sup>th</sup>~6<sup>th</sup> digits:

For Thin Film Chip Resistors, these 2 digits will be used to indicate the requested Temperature Coefficient.

(1) 05=5PPM (2) 10=10PPM (3) 15=15PPM (4) 25=25PPM (5) 50=50PPM

2.3 The 7<sup>th</sup> digit is to denote the Resistance Tolerance. The following letter code is to be used for indicating the standard Resistance Tolerance.

B= $\pm 0.10\%$  C= $\pm 0.25\%$  D= $\pm 0.50\%$  F= $\pm 1.00\%$

2.4 The 8<sup>th</sup> to 11<sup>th</sup> digits is to denote the Resistance Value.

2.4.1 For the standard resistance values of TC series, the 8<sup>th</sup> digit to the 10<sup>th</sup> digits is to denote the significant figures of the resistance and the 11<sup>th</sup> digit is the zeros following.

2.4.2 The following number s and the letter codes is to be used to indicate the number of zeros in the 11<sup>th</sup> digit:

0= $10^0$  1= $10^1$  2= $10^2$  3= $10^3$  4= $10^4$  5= $10^5$  6= $10^6$  J= $10^{-1}$  K= $10^{-2}$  L= $10^{-3}$  M= $10^{-4}$

2.4.3 The 12<sup>th</sup>, 13<sup>th</sup> & 14<sup>th</sup> digits.

The 12<sup>th</sup> digit is to denote the Packaging Type with the following codes:

C=Bulk T=Tape/Reel

2.4.4 The 13<sup>th</sup> digit is normally to indicate the Packing Quantity of Tape/Box & Tape/Reel packaging types. The following letter code and number is to be used for some packing quantities:

4=4000pcs 5=5000pcs C=10000pcs D=20000pcs E=15000pcs

Chip Product: BD=B/B-20000pcs TC=T/R-10000pcs

2.4.5 The 14<sup>th</sup> digit

This is to indicate the wattage or power rating:

B=1/32W; C=1/16W; F=1/10W; G=1/8W; H=1/6W;

J=1/4W; K=1/3W; M=1/2W; N=3/4W; P=1W;

S=Special

## 3. Ordering Procedure

(Example: TA03 1/10W  $\pm 0.1\%$  10K $\Omega$  25PPM T/R-5000)

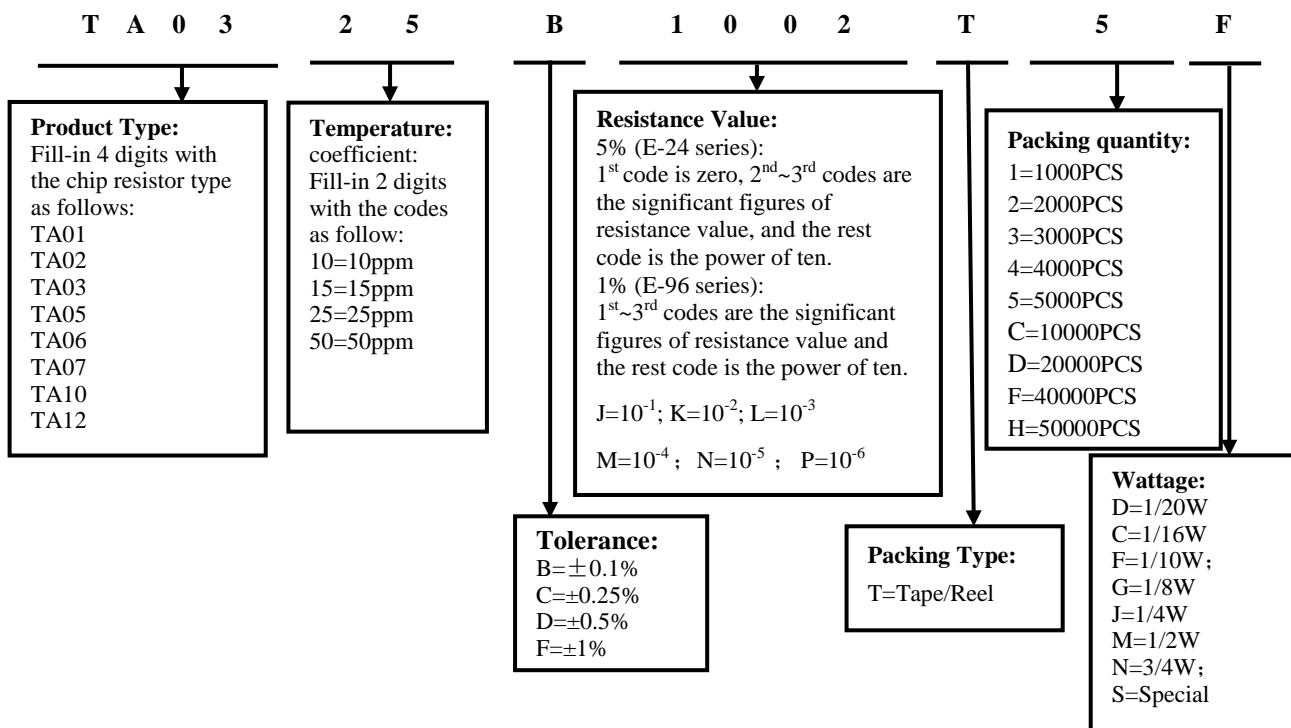

## 4. Marking



0201~0402: no marking



0603: 3 digits



0805~2512: 4 digits

4.1 TA01 and TA02 : No marking

4.2 TA03: 3 digits

4.2.1 For E-24 values:

Resistance	4.7Ω	33Ω	470Ω	5.6KΩ	62KΩ	680KΩ
3 digits code	4R7	330	471	562	623	684

E-24	10	11	12	13	15	16	18	20	22	24	27	30	33	36	39	43	47	51	56	62	68	75	82	91
------	----	----	----	----	----	----	----	----	----	----	----	----	----	----	----	----	----	----	----	----	----	----	----	----

### 4.2.2 Standard E-96 Values and 0603 Resistance Codes

Value	Code	Value	Code	Value	Code	Value	Code
100	01	178	25	316	49	562	73
102	02	182	26	324	50	576	74
105	03	187	27	332	51	590	75
107	04	191	28	340	52	604	76
110	05	196	29	348	53	619	77
113	06	200	30	357	54	634	78
115	07	205	31	365	55	649	79
118	08	210	32	374	56	665	80
121	09	215	33	383	57	681	81
124	10	221	34	392	58	698	82
127	11	226	35	402	59	715	83
130	12	232	36	412	60	732	84
133	13	237	37	422	61	750	85
137	14	243	38	432	62	768	86
140	15	249	39	442	63	787	87
143	16	255	40	453	64	806	88
147	17	261	41	464	65	825	89
150	18	267	42	475	66	845	90
154	19	274	43	487	67	866	91
158	20	280	44	499	68	887	92
162	21	287	45	511	69	909	93
165	22	294	46	523	70	931	94
169	23	301	47	536	71	953	95
174	24	309	48	549	72	976	96

#### E-96 Multiplier Code

Code	A	B	C	D	E	F	G	H	X	Y	Z
Multiplier	10 <sup>0</sup>	10 <sup>1</sup>	10 <sup>2</sup>	10 <sup>3</sup>	10 <sup>4</sup>	10 <sup>5</sup>	10 <sup>6</sup>	10 <sup>7</sup>	10 <sup>-1</sup>	10 <sup>-2</sup>	10 <sup>-3</sup>

0603 3 digits coding formula for E-96 values as following:

 Example: Example: 10.2KΩ =  $\underline{102} \times \underline{10^2} \Omega = 02C$ 

02 C

### 4.3 TA05 ~ TA12 : 4 digit marking

First 3 digits are the significant figures, the 4th digit is the multiplier. "R"= decimal point.

Examples:

Resistance	5.6Ω	10Ω	22.6Ω	100Ω	1.1KΩ	10KΩ	332KΩ	1MΩ
4 digits code	5R60	10R0	22R6	1000	1101	1002	3323	1004

## 5. Standard Electrical Specifications

Type	Rated Power at 70°C	Max Working Voltage	Max Overload Voltage	T.C.R. (PPM/°C)	Resistance Range					
					B ±0.1%	C ±0.25%	D ±0.5%	F ±1%		
TA01 (0201)	1/20W	25V	50V	±10	22 Ω ~ 5 KΩ					
				±15	22 Ω ~ 5 KΩ					
				±25	22 Ω ~ 75 KΩ					
				±50	22 Ω ~ 75 KΩ					
TA02 (0402)	1/16W	50V	100V	±10	10 Ω ~ 68 KΩ					
				±15	10 Ω ~ 68 KΩ					
				±25	4.7 Ω ~ 220 KΩ		2.49 Ω ~ 220 KΩ			
				±50	4.7 Ω ~ 220 KΩ		2.49 Ω ~ 220 KΩ			
TA03 (0603)	1/10W	75V	150V	±10	10 Ω ~ 332 KΩ					
				±15	10 Ω ~ 332 KΩ					
				±25	4.7 Ω ~ 680 KΩ		2.49 Ω ~ 680 KΩ			
				±50	4.7 Ω ~ 680 KΩ		2.49 Ω ~ 680 KΩ			
TA05 (0805)	1/8W	150V	300V	±10	10 Ω ~ 680 KΩ					
				±15	10 Ω ~ 680 KΩ					
				±25	4.7 Ω ~ 1 MΩ		2.49 Ω ~ 1 MΩ			
				±50	4.7 Ω ~ 1 MΩ		2.49 Ω ~ 1 MΩ			
TA06 (1206)	1/4W	200V	400V	±10	10 Ω ~ 1 MΩ					
				±15	10 Ω ~ 1 MΩ					
				±25	4.7 Ω ~ 1.5 MΩ		2.49 Ω ~ 1.5 MΩ			
				±50	4.7 Ω ~ 1.5 MΩ		2.49 Ω ~ 1.5 MΩ			
TA07 (1210)	1/4W			200V	400V	±10	10 Ω ~ 1 MΩ			
						±15	10 Ω ~ 1 MΩ			
						±25	4.7 Ω ~ 1 MΩ		2.49 Ω ~ 1 MΩ	
						±50	4.7 Ω ~ 1 MΩ		2.49 Ω ~ 1 MΩ	
TA10 (2010)	1/2W	200V	400V			±10	10 Ω ~ 1 MΩ			
						±15	10 Ω ~ 1 MΩ			
						±25	4.7 Ω ~ 1 MΩ		2.49 Ω ~ 1 MΩ	
						±50	4.7 Ω ~ 1 MΩ		2.49 Ω ~ 1 MΩ	
TA12 (2512)	3/4W			200V	400V	±10	10 Ω ~ 1 MΩ			
						±15	10 Ω ~ 1 MΩ			
						±25	4.7 Ω ~ 1 MΩ		2.49 Ω ~ 1 MΩ	
						±50	4.7 Ω ~ 1 MΩ		2.49 Ω ~ 1 MΩ	

For non-standard parts, please contact our sales dept.

Operating Temperature Range : -55°C ~ +155°C.

**6. Dimension**

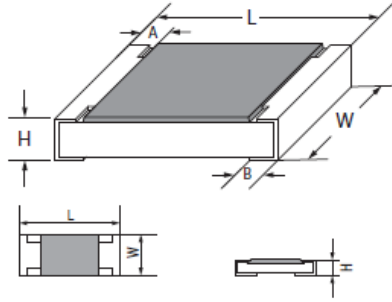

Unit: mm

Type	L	W	H	A	B
TA01	0.60 ± 0.05	0.30 ± 0.05	0.23 ± 0.05	0.12 ± 0.05	0.15 ± 0.05
TA02	1.00 ± 0.10	0.50 ± 0.05	0.30 ± 0.05	0.20 ± 0.10	0.20 ± 0.10
TA03	1.60 ± 0.15	0.80 ± 0.10	0.45 ± 0.10	0.30 ± 0.20	0.30 ± 0.20
TA05	2.00 ± 0.15	1.25 ± 0.15	0.55 ± 0.10	0.35 ± 0.20	0.40 ± 0.20
TA06	3.10 ± 0.15	1.60 ± 0.15	0.55 ± 0.10	0.45 ± 0.20	0.50 ± 0.20
TA07	3.10 ± 0.15	2.50 ± 0.15	0.55 ± 0.10	0.45 ± 0.20	0.50 ± 0.20
TA10	5.00 ± 0.15	2.50 ± 0.15	0.55 ± 0.10	0.60 ± 0.20	0.60 ± 0.20
TA12	6.30 ± 0.15	3.20 ± 0.15	0.55 ± 0.10	0.60 ± 0.20	0.60 ± 0.20

**7. Structure**

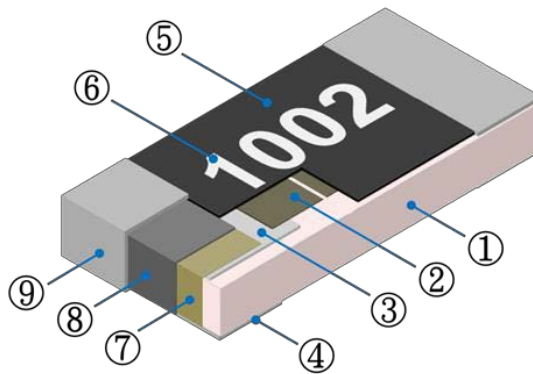

①	Alumina Substrate	⑥	Marking
②	Resistive Layer	⑦	Side Inner Electrode
③	Top Inner Electrode	⑧	Nickel Barrier
④	Bottom Inner Electrode	⑨	Solder coating (Sn)
⑤	Protective Overcoat		

**8. Soldering pad size recommended**

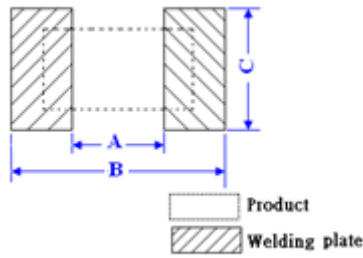

Type	Dimension(mm)		
	A	B	C
TA01	0.25	0.85	0.35
TA02	0.50	1.60	0.70
TA03	0.80	2.40	1.00
TA05	1.30	2.90	1.40
TA06	2.20	4.20	1.70
TA07	2.00	4.40	2.70
TA10	3.80	6.60	2.70
TA12	4.90	8.10	3.40

**9. Derating Curve**

Power rating will change based on continuous load at ambient temperature from -55 to 155°C. It is constant between -55 to 70°C, and derate to zero when temperature rise from 70 to 155°C.

Voltage rating:

Rated Current: The resistor shall have a DC continuous working current or a AC (rms) continuous working current at commercial-line frequency and wave form corresponding to the power rating, as determined formula as following:

$$V = \sqrt{P \times R}$$

V = Rated voltage (V)  
 P = Rated power (W)  
 R = Nominal resistance (Ω)

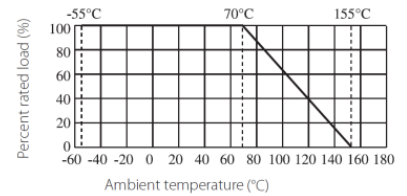

**10. Performance Specification**

Test Item	Test Method	Procedure	Requirements
Temperature Coefficient of Resistance (T.C.R)	JIS-C-5201-1 clause 4.8	At +25°C/-55°C and +25°C/+125°C.	Refer to Standard Electrical Specifications
Short Time Overload	JIS-C-5201-1 clause 4.13	2.5 times RCWV or Max. Overload voltage whichever is less for 5 seconds.	±(0.5%+0.05Ω) No Visual damage
Insulation Resistance	JIS-C-5201-1 clause 4.6	100V for 1 minute.	≧ 10GΩ
Solderability	JIS-C-5201-1 clause 4.17	245±5°C for 3±0.5secs.	>95% Coverage No Visual damage
Resistance to Soldering Heat	JIS-C5201-1 clause 4.18	260±5°C for 10 seconds.	±(0.5%+0.05Ω) No Visual damage
Leaching	JIS-C5201-1 clause 4.18	260±5°C for 30 seconds.	>95% Coverage No Visual damage
Temperature Cycling	JIS-C-5201-1 clause 4.19	-55°C to +155°C, 300 cycles	±(0.5%+0.05Ω) No Visual damage

High Temperature Exposure	JIS-C-5201-1 clause 4.25	155±5°C for 1000 +48/-0 hours.	±(0.5%+0.05Ω)
Resistance to Solvent	JIS-C-5201-1 clause 4.29	The tested resistor be immersed into isopropyl alcohol of 20~25°C for 60 secs. Then the resistor is left in the room for 48 hrs.	±(0.5%+0.05Ω) No Visual damage
Load Life in Humidity	JIS-C-5201-1 clause 4.24	40±2°C, 90~95% R.H. , Rated power or Max. working current whichever is less for 1000 hrs with 1.5 hrs "ON" and 0.5 hr "OFF" .	±(0.5%+0.05Ω)
Biased Humidity	MIL-STD-202 Method 103	1,000 hours; 85°C / 85% RH, 10% of operating power. Measurement at 24±4 hours after test conclusion.	±(0.5%+0.05Ω)
Load Life (Endurance)	JIS C 5201-1 clause 4.25	70±2°C, Rated power, or Max. working current whichever is less for 1000 hrs with 1.5 hrs "ON" and 0.5 hr "OFF" .	±(0.5%+0.05Ω)
Terminal Bending Strength	JIS C 5201-1 clause 4.33	Bending once for 5 seconds D: 0201、0402、0603、0805 = 5mm 1206、1210 = 3mm 2010、2512 = 2mm	±(0.5%+0.05Ω) No Visual damage

We can also provide AEC-Q200 test reports if required by customers.

**11. Recommended Customer Soldering Parameters**

11.1 Wave solder Temperature condition

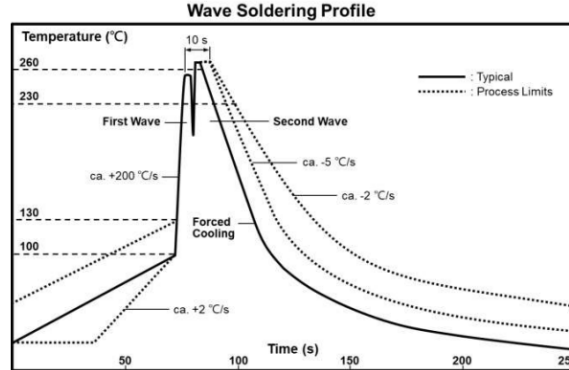

11.2 Solder reflow Temperature condition

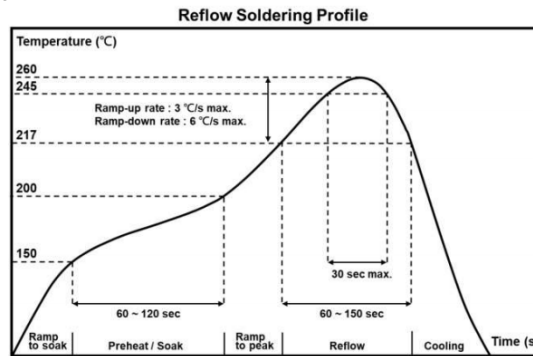

11.3 Rework temperature ( hot air equipment ) : 350°C, 3~5seconds

11.4 Recommended reflow methods

IR, vapor phase oven, hot air oven

If reflow temperatures exceed the recommended profile, devices may not meet the performance requirements.

12. Packing

12.1 Tapping Specification:(Unit: mm)

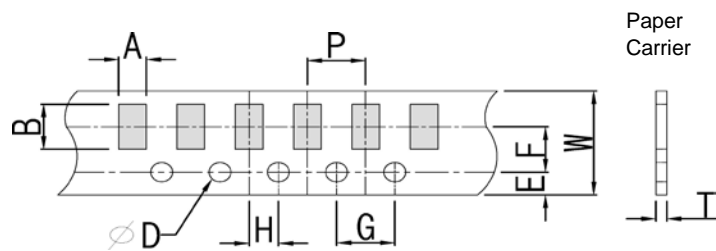

Type	A	B	W	E	F	G	H	T	ΦD	P
TA01	0.40±0.05	0.70±0.05	8.0±0.20	1.75±0.10	3.5±0.05	4.0±0.10	2.0±0.05	0.45±0.10	1.50 <sup>+0.10</sup> <sub>-0</sub>	2.0±0.10
TA02	0.70±0.10	1.20±0.10	8.0±0.20	1.75±0.10	3.5±0.05	4.0±0.10	2.0±0.05	0.45±0.10		
TA03	1.05±0.20	1.80±0.20	8.0±0.20	1.75±0.10	3.5±0.05	4.0±0.10	2.0±0.05	0.60±0.10		4.0±0.10
TA05	1.55±0.20	2.30±0.20	8.0±0.20	1.75±0.10	3.5±0.05	4.0±0.10	2.0±0.05	0.75±0.10		
TA06	1.90±0.20	3.50±0.20	8.0±0.20	1.75±0.10	3.5±0.05	4.0±0.10	2.0±0.05	0.75±0.10		
TA07	2.85±0.20	3.50±0.20	8.0±0.20	1.75±0.10	3.5±0.05	4.0±0.10	2.0±0.05	0.75±0.10		

12.2 Embossed Dimension:(Unit: mm)

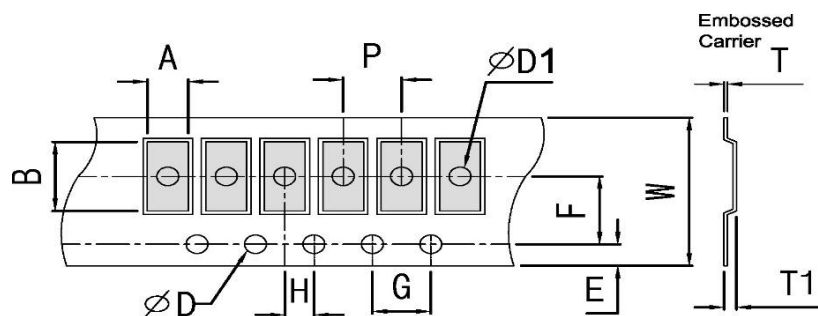

Type	A	B	W	E	F	G	H	T	ΦD	ΦD1	T1	P
TA10	2.80±0.20	5.60±0.20	12±0.10	1.75±0.10	5.5±0.05	4.0±0.10	2.0±0.05	0.23±0.10	1.50 <sup>+0.10</sup> <sub>-0</sub>	1.50±0.10	0.85±0.15	4.0±0.10
TA12	3.40±0.20	6.70±0.20	12±0.10	1.75±0.10	5.5±0.05	4.0±0.10	2.0±0.05	0.23±0.10		1.50±0.10	0.85±0.15	



12.3 Dimension of Reel : (Unit: mm)

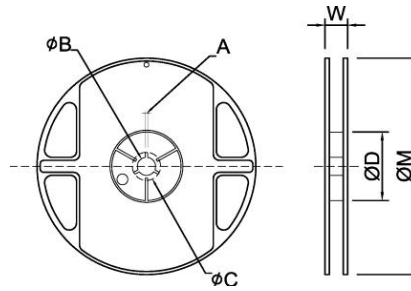

TYPE	SIZE		A	φB	φC	φD	W	φM
TA01	7"	10K/Reel	2.0±0.5	13.5±1.0	21±1.0	60±1.0	11.5±2.0	178±2.0
TA02	7"	10K/Reel	2.0±0.5	13.5±1.0	21±1.0	60±1.0	11.5±2.0	178±2.0
TA02	13"	40K/50K Reel	2.0±0.5	13.5±1.0	21±1.0	100±1.0	11.5±2.0	330±2.0
TA03/TA05/TA06/TA07	7"	5K/Reel	2.0±0.5	13.5±1.0	21±1.0	60±1.0	11.5±2.0	178±2.0
TA03/TA05/TA06	10"	10K/Reel	2.0±0.5	13.5±1.0	21±1.0	100±1.0	11.5±2.0	254±2.0
	13"	20K/Reel	2.0±0.5	13.5±1.0	21±1.0	100±1.0	11.5±2.0	330±2.0
TA10/TA12	7"	4K/Reel	2.0±0.5	13.5±1.0	21±1.0	60±1.0	16.0±2.0	178±2.0

**13. Note**

- 13.1. UNI-ROYAL recommend products store in warehouse with temperature between 15 to 35°C under humidity between 25 to 75%RH. Even under storage conditions recommended above, solder ability of products will be degraded stored over 1 year old.
- 13.2. Cartons must be placed in correct direction which indicated on carton, otherwise the reel or wire will be deformed.
- 13.3. Storage conditions as below are inappropriate:
  - a. Stored in high electrostatic environment
  - b. Stored in direct sunshine, rain, snow or condensation.
  - c. Exposed to sea wind or corrosive gases, such as Cl<sub>2</sub>, H<sub>2</sub>S, NH<sub>3</sub>, SO<sub>2</sub>, NO<sub>2</sub>, etc.

**14. Record**

Version	Description	Page	Date	Amended by	Checked by
1	First version	1~9	Dec.10, 2019	Haiyan Chen	Yuhua Xu

© Uniroyal Electronics Global Co., Ltd. All rights reserved. Specification herein will be changed at any time without prior notice.