



UNI-ROYAL
厚聲集團

DATA SHEET

Product Name Power Metal Fixed Resistors

Part Name PMR Series

File No. DIP-SP-003

Uniroyal Electronics Global Co., Ltd.

88#, Longteng Road, Economic & Technical Development Zone, Kunshan, Jiangsu, China

Tel +86 512 5763 1411 / 22 /33

Email marketing@uni-royal.cn

Manufacture Plant Uniroyal Electronics Industry Co., Ltd.

Aeon Technology Corporation

Royal Electronic Factory (Thailand) Co., Ltd.

Royal Technology (Thailand) Co., Ltd.

1. Scope

- 1.1 This specification for approve relates Power Metal Fixed Resistors manufactured by UNI-ROYAL
- 1.2 High power in small body size
- 1.3 Excellent flame Retardant coating
- 1.4 High stability even in bad environment
- 1.5 Match the safety requirement

2. Part No. System

The standard Part No. includes 14 digits with the following explanation:

- 2.1 Coated type, the 1st to 3rd digits are to indicate the product type and 4th digit is the special feature.

Example: PMR0= Power Metal Fixed Resistors

- 2.2 5th~6th digits:

- 2.2.1 This is to indicate the wattage or power rating. To dieting the size and the numbers,

The following codes are used; and please refer to the following chart for detail:

W=Normal Size “1”~“G”to denotes“1”~“16”as Hexadecimal:

1W~16W ($\geq 1W$)

Wattage	1	2	3	5	7	8	9	10	15
Normal Size	1W	2W	3W	5W	7W	8W	9W	AW	FW
Small Size	1S	2S	3S	5S	7S	8S	9S	AS	FS

- 2.2.2 For power of 1 watt to 16 watt, the 5th digit will be a number or a letter code and the 6th digit will be the letters of W, S or U.

Example: 1W=1W; 3W=3W

- 2.3 The 7th digit is to denote the Resistance Tolerance. The following letter code is to be used for indicating the standard Resistance Tolerance.

F=±1% G=±2% J=±5% K= ±10%

- 2.4 The 8th to 11th digits is to denote the Resistance Value.

- 2.4.1 For the standard resistance values of E-24 series, the 8th digit is “0”,the 9th & 10th digits are to denote the significant figures of the resistance and the 11th digit is the number of zeros following;

For the standard resistance values of E-96 series, the 8th digit to the 10th digits is to denote the significant figures of the resistance and the 11th digit is the zeros following.

- 2.4.2 The following number s and the letter codes are to be used to indicate the number of zeros in the 11th digit:

0=10⁰ 1=10¹ 2=10² 3=10³ 4=10⁴ 5=10⁵
 6=10⁶ J=10⁻¹ K=10⁻² L=10⁻³ M=10⁻⁴

- 2.4.3 The 12th, 13th & 14th digits.

The 12th digit is to denote the Packaging Type with the following codes:

A=Tape/Box (Ammo pack) B=Bulk/Box

T=Tape/Reel P=Tape/Box of PT-26 products

- 2.4.4 The 13th digit is normally to indicate the Packing Quantity of Tape/Box packaging types. The following number is to be used for some packing quantities:

1=1000pcs 2=2000pcs 3=3000pcs 4=4000pcs 5=5000pcs

- 2.4.5 For some items, the 14th digit alone can use to denote special features of additional information with the following codes:

0=NIL P=Panasert type 1=Avisert type 1 2=Avisert type 2
 3=Avisert type 3 8=PT-58mm 9=PT-64mm 7=Lead wire(H)38mm
 A=PT-83mm C=PT-73mm D=PT-71mm

3. Ordering Procedure

(Example: PMR 2WS ±5% 39KΩ T/B-1000)

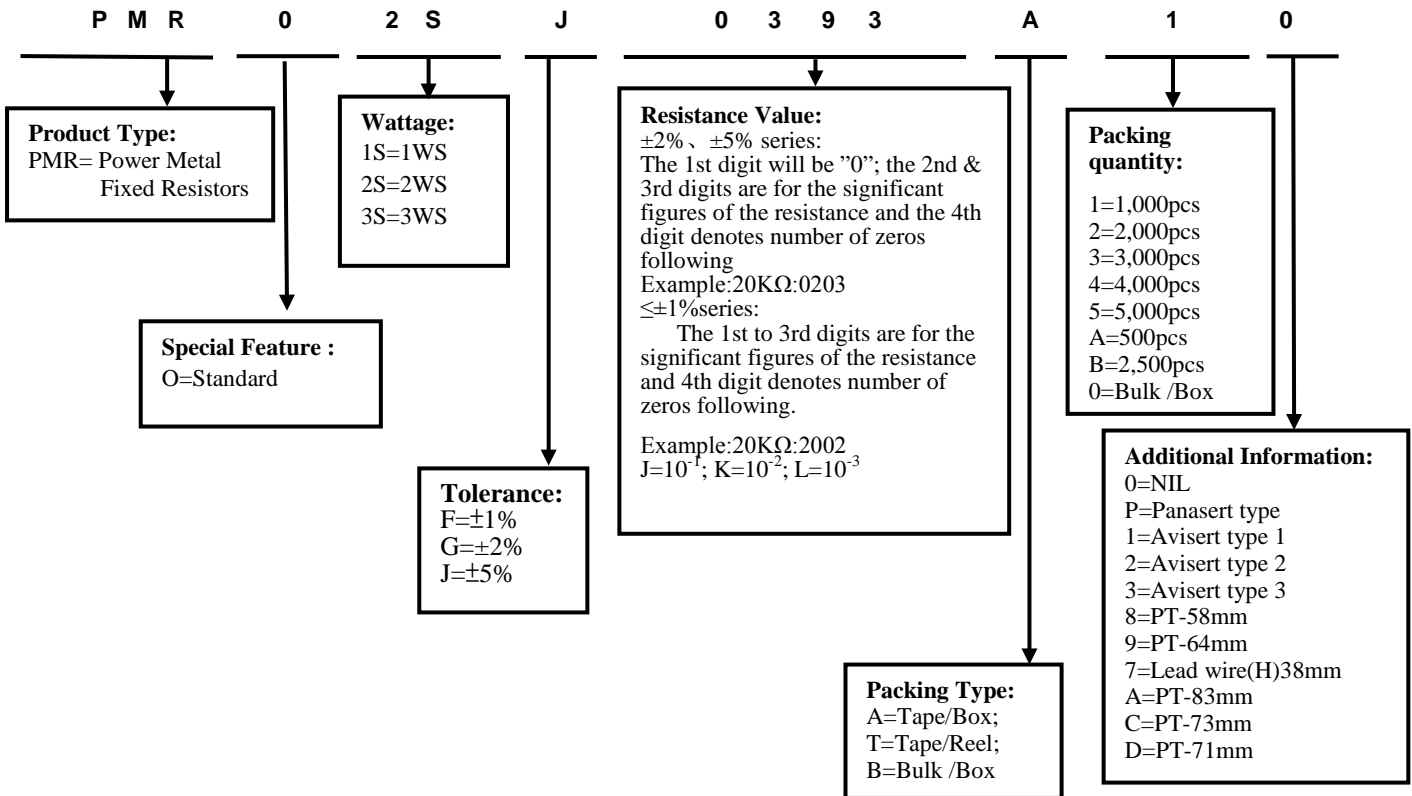

4. Marking

Resistors shall be marked with color coding , Colors shall be in accordance with JIS C 0802

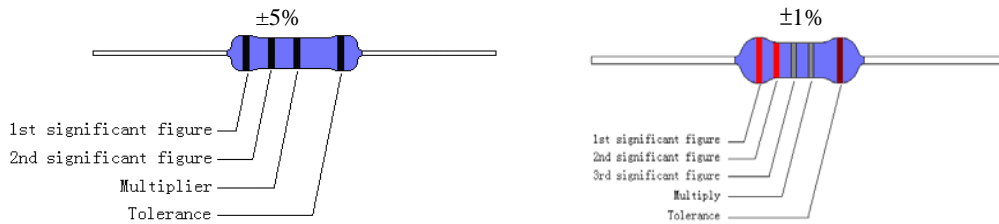

4.1 Label:

Label shall be marked with following items:

- (1) Type and style
- (2) Nominal resistance
- (3) Resistance tolerance
- (4) Quantity
- (5) Lot number
- (6) PPM

Example:

Power Metal Fixed Resistors	
WATT: 1WS	VAL: 33Ω
Q'TY: 5,000	TOL: 1%
LOT: 7011248	PPM:

5. Ratings & Dimension



Type	Dimension(mm)				PT	Max Working Voltage	Max Overload Voltage	Dielectric Withstanding Voltage	Tolerance	Resistance Range
	D	L ±1.0	d ±0.05	H ±3						
PMR 1WS	2.2±0.5	6.5	0.54	28	52	350V	400V	350V	±1%、±2%、±5%	0.56Ω~1MΩ
PMR 2WS	4.0±0.6	11.0	0.70	25	52	500V	600V	350V	±1%、±2%、±5%	3.9Ω~680KΩ
PMR 3WS	5.0±0.6	15.5	0.75	28	64	750V	800V	350V	±1%、±2%、±5%	12Ω~180KΩ

6. Derating Curve

Power rating will change based on continuous load at ambient temperature from -55 to 155°C. It is constant between -55 to 70°C, and derate to zero when temperature rise from 70 to 155°C.

Voltage rating:

Resistors shall have a rated direct-current (DC) continuous working voltage or an approximate sine-wave root-mean-square (RMS) alternating-current (AC) continuous working voltage at commercial-line frequency and waveform corresponding to the power rating, as determined from the following formula:

$$RCWV = \sqrt{P \times R}$$

Remark: RCWV: Rating Continuous Working Voltage (Volt.) P: power rating (Watt) R: nominal resistance (Ω)

In no case shall the rated DC or RMS AC continuous working voltage be greater than the applicable maximum value.

The overload voltage is 2.5 times RCWV or Max. Overload voltage whichever is lower.

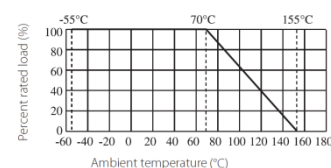

7. Structure

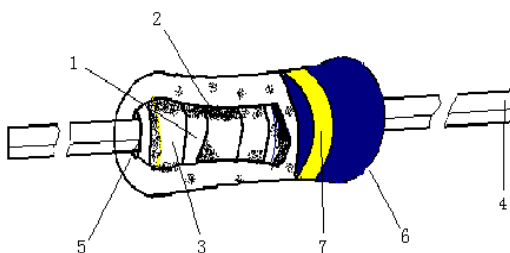

No.	Name	Material
1	Basic body	Rod type ceramics
2	Resistor	Metal Oxide Film & MGR Film
3	End cap	Steel (Tin plated iron surface)
4	Lead wire	Tin solder coated copper wire
5	Joint	By welding
6	Coating	Insulated resin Color: Sea Blue
7	Color code	Epoxy resin

8. Performance Specification

Characteristic	Limits		Test methods (GB/T5729&JIS-C-5201&IEC60115-1)
Temperature Coefficient	1WS	0.56Ω~100KΩ: ±350 PPM/°C 101KΩ~470KΩ: ±400 PPM/°C 471KΩ~1MΩ: ±800 PPM/°C	4.8 Natural resistance changes per temp. Degree centigrade $R_2 - R_1$ $\frac{R_2 - R_1}{R_1(t_2 - t_1)} \times 10^6$ (PPM/°C) R ₁ : Resistance Value at room temperature (t ₁) ; R ₂ : Resistance at test temperature (t ₂) t ₁ : +25°C or specified room temperature t ₂ : Test temperature (-55°C or 125°C)
	2WS	3.9Ω~100KΩ: ±350 PPM/°C 101KΩ~680KΩ: ±400 PPM/°C	
	3WS	12Ω~100KΩ: ±350 PPM/°C 101KΩ~180KΩ: ±400 PPM/°C	

Short-time overload	$\Delta R/R \leq \pm(2\%+0.05 \Omega)$, with no evidence of mechanical damage	4.13 Permanent resistance change after the application of a potential of 2.5 times RCWV or the max. Overload voltage respectively specified in the above list, whichever less for 5 seconds.
Terminal strength	Neither breakage of the lead wire nor loosening of termination	4.16 direct load: Resistance to a 2.5 kg direct load for 10 seconds in the direction of the longitudinal axis of the terminal leads. Twist test: Terminal leads shall be bent through 90° at a point of about 6mm from the body of the resistor and shall be rotated through 360° about the original axis of the bent terminal in alternating direction for a total of 3 rotations.
Resistance to soldering heat	$\Delta R/R \leq \pm(1\%+0.05 \Omega)$, with no evidence of mechanical damage	4.18 Permanent resistance change when leads immersed to a point 2.0-2.5mm from the body in 260°C ±5°C, solder for 10±1 seconds.
Solderability	Coverage must be over 95%.	4.17 The area covered with a new, smooth, clean, shiny and continuous surface free from concentrated pinholes. Test temp. of solder: 245°C ±3°C Dwell time in solder: 2~3seconds.
Rapid change of temperature	$\Delta R/R \leq \pm(2\%+0.05 \Omega)$ with no evidence of mechanical damage	4.19 30 min at -55 °C and 30 min at 155°C; 100 cycles.
Load life in humidity	1WS: $\Delta R/R \leq \pm(5\%+0.05 \Omega)$ Max; 2WS&3WS: <100KΩ: $\Delta R/R \leq \pm(5\%+0.05 \Omega)$ Max ≥100KΩ: $\Delta R/R \leq \pm(10\%+0.05 \Omega)$ Max	7.9 Resistance changes after 1,000 hours operating at RCWV with duty cycle of 1.5 hours “on”, 0.5 hour “off” in a humidity test chamber controlled at 40°C ±2°C and 90 - 95% relative humidity.
Load life	1WS: $\Delta R/R \leq \pm(5\%+0.05 \Omega)$ Max; 2WS&3WS: <100KΩ: $\Delta R/R \leq \pm(5\%+0.05 \Omega)$ Max ≥100KΩ: $\Delta R/R \leq \pm(10\%+0.05 \Omega)$ Max	4.25.1 Permanent resistance change after 1,000 hours operating at RCWV with duty cycle of 1.5 hours “on”, 0.5 hour “off” at 70°C ±2 °C ambient.
Flame retardant	Resistor insulation is self-extinguishing within 10 seconds after externally applied flame is removed.	7.12 The burner is placed remote fro, resistor ignited and adjusted to produce a blue flame 38mm in height and a top of flame 127mm above the top of burner tube. Resistor is supported from its lead at 45° from the horizontal so that the lower end of resistor is the top of blue flame. The test flame is placed to remain for 15 seconds and removed for 15 seconds. The operation is to be repeated until resistor has been subjected to 5 application of test flame.
Low Temperature Storage	1WS: $\Delta R/R \leq \pm(5\%+0.05 \Omega)$ Max; 2WS&3WS: <100KΩ: $\Delta R/R \leq \pm(5\%+0.05 \Omega)$ Max ≥100KΩ: $\Delta R/R \leq \pm(10\%+0.05 \Omega)$ Max	IEC 60068-2-1 (Aa) Lower limit temperature , for 2H.
High Temperature Exposure	1WS: $\Delta R/R \leq \pm(5\%+0.05 \Omega)$ Max; 2WS&3WS: <100KΩ: $\Delta R/R \leq \pm(5\%+0.05 \Omega)$ Max ≥100KΩ: $\Delta R/R \leq \pm(10\%+0.05 \Omega)$ Max	MIL-STD-202 108A Upper limit temperature , for 16H.

9. Packing

9.1 Tapes in Box Packing

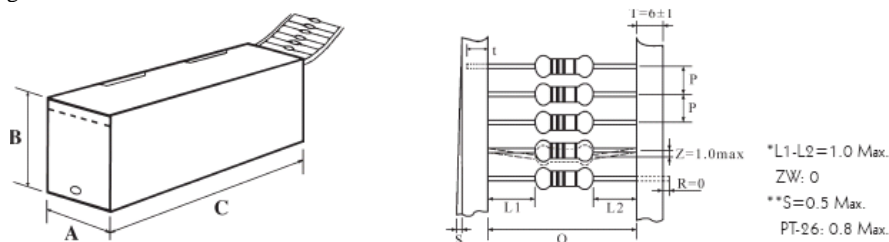

Dimension of T/B (mm)

Part No.	O	P	A±5	B±5	C±5	Qty/Box
PMR 1WS	52±1	5±0.3	75	98	255	5,000pcs
PMR 2WS	52±1	5±0.3	86	82	255	1,000pcs
PMR 3WS	64±5	10±0.5	90	88	255	1,000pcs

9.2 Tapes in Reel Packing

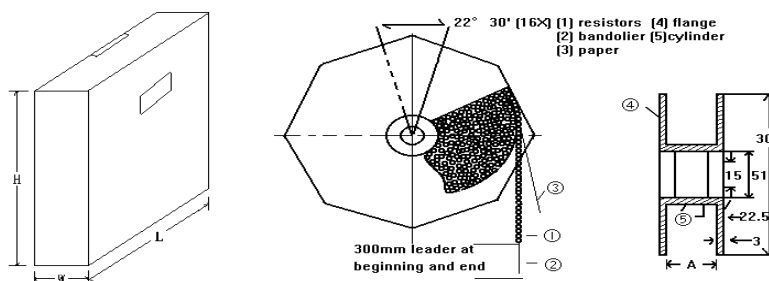

Dimension of Reel (mm)

Part No.	O	A	W±5	H±5	L±5	Qty/Box
PMR 1WS	52±1	73±2	85	295	293	5,000pcs
PMR 2WS	52±1	73±2	85	295	293	2,500pcs
PMR 3WS	64±5	80±5	95	295	293	1,000pcs

9.3 Bulk in Box Packing

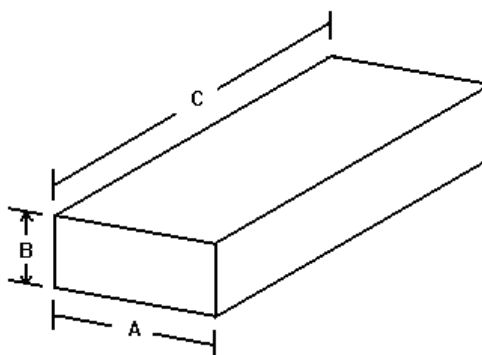

Dimension of Box (mm)

Part No.	A±5	B±5	C±5	Qty/Box
PMR 1WS	140	80	240	500/10,000pcs
PMR 2WS	140	80	240	100/2,500pcs
PMR 3WS	140	80	240	100/1,500pcs

10. Note

- 10.1. UNI-ROYAL recommend products store in warehouse with temperature between 15 to 35°C under humidity between 25 to 75%RH.
 Even under storage conditions recommended above, solder ability of products will be degraded stored over 1 year old.
- 10.2. Cartons must be placed in correct direction which indicated on carton, otherwise the reel or wire will be deformed.
- 10.3. Storage conditions as below are inappropriate:
- Stored in high electrostatic environment
 - Stored in direct sunshine, rain, snow or condensation.
 - Exposed to sea wind or corrosive gases, such as Cl₂, H₂S, NH₃, SO₂, NO₂, Br etc.

11. Record

Version	Description	Page	Date	Amended by	Checked by
1	First version	1~7	Mar.20, 2018	Haiyan Chen	Nana Chen
2	Modify characteristic	5~6	Feb.19, 2019	Haiyan Chen	Yuhua Xu
3	Modify 1WS Max Working Voltage, Max Overload Voltage, Resistance Range, Temperature Coefficient	4	Aug.07, 2020	Haiyan Chen	Yuhua Xu
4	Modify the temperature coefficient test conditions	4	Oct.28, 2022	Haiyan Chen	Yuhua Xu

© Uniroyal Electronics Global Co., Ltd. All rights reserved. Specification herein will be changed at any time without prior notice