

DATASHEET

Product Name Metal Strip Chip Resistors

Part Name LR06、LR12 Series

File No. SMD-SP-016

Uniroyal Electronics Global Co., Ltd.

88#, Longteng Road, Economic & Technical Development Zone, Kunshan, Jiangsu, China

Tel +86 512 5763 1411 / 22 /33

Email marketing@uni-royal.cn

Manufacture Plant Uniroyal Electronics Industry Co., Ltd.

Aeon Technology Corporation

Royal Electronic Factory (Thailand) Co., Ltd.

Royal Technology (Thailand) Co., Ltd.

1. Scope

- 1.1 This datasheet for approve relates to the Metal Strip Chip Resistors manufactured by UNI-ROYAL.
- 1.2 Low TCR
- 1.3 Low inductance
- 1.4 AEC-Q200 compliant.
- 1.5 Compliant with RoHS directive.
- 1.6 Halogen free requirement.

2. Part No. System

Part No. includes 14 codes shown as below:

2.1 1st~4th codes: Part name. E.g.: LR06, LR12

2.2 5th~6th codes: Power rating.

Wattage	1	1.5	2	3
Normal Size	1W	1A	2W	3W

2.3 7th code: Tolerance. E.g.: F=±1% J=±5%

2.4 8th~11th codes: Resistance Value.

2.4.1 If value belongs to standard value of ±1% series, 8th~10th codes are significant figures of the resistance, and 11th code is the power of ten.

2.4.3 11th codes listed as following:

$$0=10^0 \quad 1=10^1 \quad 2=10^2 \quad 3=10^3 \quad 4=10^4 \quad 5=10^5 \quad 6=10^6 \quad J=10^{-1} \quad K=10^{-2} \quad L=10^{-3} \quad M=10^{-4} \quad N=10^{-5} \quad P=10^{-6}$$

2.5 12th~14th codes.

2.5.1 12th code: Packaging Type. E.g.: T=Tape/Reel

2.5.2 13th code: Standard Packing Quantity.

$$4=4000\text{pcs} \quad 5=5000\text{pcs}$$

2.5.3 14th code: Special features.

E = Standard

3. Ordering Procedure

(Example: LR12 3W ±1% 100mΩ T/R-4000)

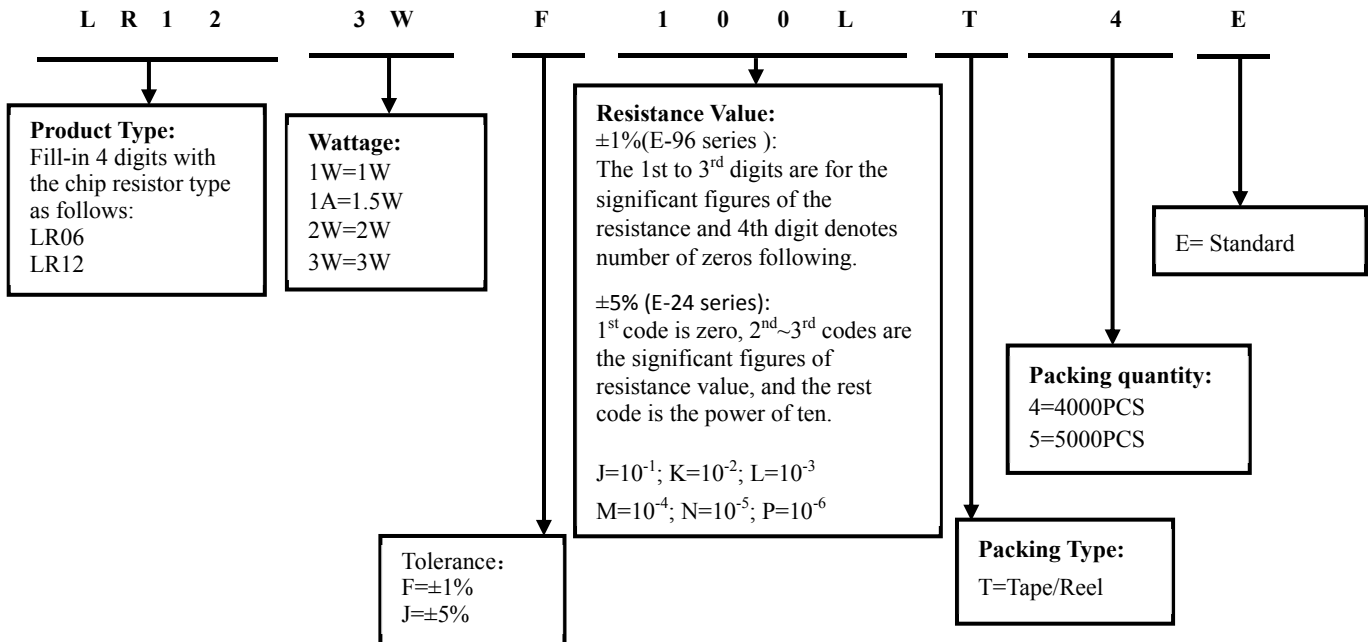

4. Marking

4.1 Normally, the products marking are 4 digits.

“R” designates the decimal location in ohms

e.g. 3mΩ the product marking is R003.

25mΩ the product marking is R025.

100mΩ the product marking is R100.

5. Dimension

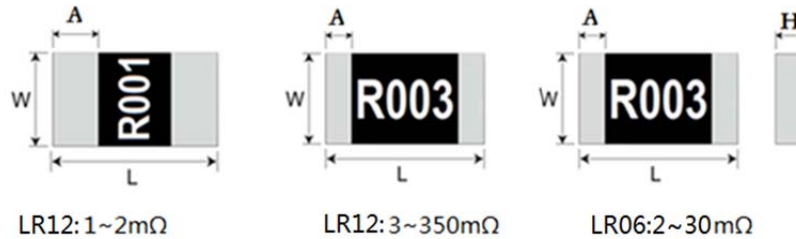

Unit: mm

Type	Power Rating	Resistance Range	L	W	H	A	Tolerance	T.C.R PPM/°C
LR06 (1206)	1W	2~30mΩ	3.20±0.25	1.60±0.25	0.65±0.25	0.70±0.30	±1% ±5%	±50
	1.5W	2~5mΩ						
LR12 (2512)	2W	1~2mΩ	6.35±0.25	3.18±0.25	0.70±0.25	2.20±0.25	±1% ±5%	±50
		3~25mΩ				0.90±0.25		
		26~350mΩ				0.90±0.25		
	3W	1~2mΩ			0.90±0.25	2.20±0.25		
		3~9mΩ				0.90±0.25		
		10~350mΩ				0.65±0.25		

6. Structure

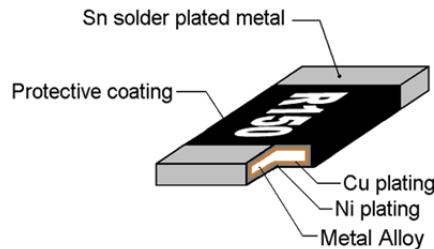

7. Derating Curve

Resistors shall have a power rating based on continuous load operation at an ambient temperature of 70°C. For temperature in excess of 70°C, The load shall be derate as shown in figure 1.

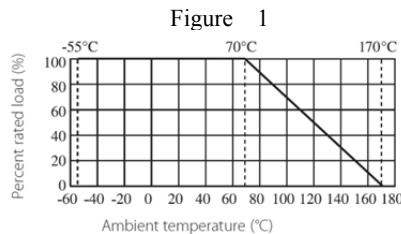

The following equation may be used to determine the DC (Direct Current) or AC (Alternating Current) (RMS, root mean square value) of normal rated power. However, if the result value exceeds the highest current of regulated standards, the highest normal rated power is to be used

$$I = \sqrt{P/R}$$

I = Rating current (A)

P= Rating Power (W)

R= Resistance(Ω)

8. Performance Specification

Test Item	Test Method	Test Methods	Requirement
Electrical Characterization (T.C.R)	GB/T 5729 4.8 JIS-C-5201 4.8 IEC 60115-1 6.2	Natural resistance changes per temp. Degree centigrade $\frac{R_2 - R_1}{R_1(t_2 - t_1)} \times 10^6 \text{ (PPM/}^\circ\text{C)}$ R ₁ : Resistance Value at room temperature (t ₁) ; R ₂ : Resistance at test temperature (t ₂) t ₁ : +25°C or specified room temperature t ₂ : Test temperature (+125°C)	±50PPM/°C
Short time overload	GB/T 5729 4.13 JIS-C-5201 4.13 IEC 60115-1 8.1.4.2	LR06,LR12 2W:5 times of rated power for 5 seconds LR12 3W:4 times of rated power for 5 seconds	ΔR≤±(0.5%+0.0005Ω)
Operational Life	MIL-STD-202 Method 108	125°C, at 36% of operating power, 1000H(1.5 hours “ON”, 0.5 hour “OFF”). Measurement at 24±4 hours after test conclusion.	ΔR≤±(1.0%+0.0005Ω)
High Temperature Exposure	MIL-STD-202 Method 108	1000hrs. @T=155°C.Unpowered. Measurement at 24±4 hours after test conclusion.	ΔR≤±(1.0%+0.0005Ω)
Biased Humidity	AEC-Q200 TEST 7	10% rated power, 85°C/85%RH, 1000H, Measurement at 24±4 hours after test conclusion.	LR06: ΔR≤±(1.0%+0.0005Ω) LR12: ΔR≤±(0.5%+0.0005Ω)
Temperature Cycling	JESD22 Method JA-104	1000 Cycles (-55°C to +155°C) Measurement at 24±4 hours after test conclusion.	LR06: ΔR≤±(1.0%+0.0005Ω) LR12: ΔR≤±(0.5%+0.0005Ω)
Board Flex	AEC Q200-005	Bending 2mm(min) for 60+5sec	ΔR≤±(1.0%+0.0005Ω)
Resistance to Solder Heat	MIL-STD-202 Method 210	Condition B No per-heat of samples. Dipping the resistor into a solder bath having a temperature of 260°C±5°C and hold it for 10±1 seconds	ΔR≤±(0.5%+0.0005Ω)
Solderability	J-STD-002	Test temperature of solder : 245±3°C , Dipping them solder : 2~3 seconds	Coverage must be over 95%.
Terminal Strength	AEC-Q200-006	Force of 17.7N, 60±1 seconds.	No broken
External visual	MIL-STD-883 Method 2009	Electrical test not required. Inspect device construction, marking and workmanship	Marking Complete , no mechanical damage
Physical dimension	JESD22 MH Method JB-100	Verify physical dimensions to the applicable device detail specification. Note: User(s) and Suppliers spec. Electrical test not required.	Refer to standard size.
Resistance to solvent	MIL-STD-202 Method 215	Add Aqueous wash chemical - OKEM Clean or equivalent. Do not use banned solvents.	Marking Complete , no mechanical damage
Mechanical shock	MIL-STD-202 Method 213	Wave Form: Tolerance for half sine shock pulse. Peak value is 100g's. Normal duration (D) is 6ms.	ΔR≤±(1.0%+0.0005Ω)
Vibration	MIL-STD-202 Method 204	5g's for 20 min., 12cycle each of 3 orientations. Note: Use 8”*5”PCB. 031” thick 7 secure points (onone) long side and 2 secure points at corners of opposite sides. Parts mounted within 2” from any secure point. Test from 10-2000Hz.	ΔR≤±(1.0%+0.0005Ω)
ESD	AEC-Q200-002	With the electrometer in direct contact with the discharge tip, verify the voltage setting at levels of ±500V,±1KV, ±2KV, ±4KV, ±8KV, The electrometer reading shall be within ±10% for voltages from 500V to ≅800V.	ΔR≤±(10%+0.0005Ω)
Flammability	UL-94	V-0 or V-1 are acceptable. Electrical test not required.	No ignition of the tissue paper or scorching or the pinewood board
Flame Retardance	AEC-Q200-001	Only requested, when voltage/power will increase the surface temp to 350°C.Apply voltage from 9V to 32V. No flame; No explosion.	NO Flame

9. Soldering Condition

(This is for recommendation, please customer perform adjustment according to actual application)

9.1 Recommend Reflow Soldering Profile: (solder : Sn96.5 / Ag3 / Cu0.5)

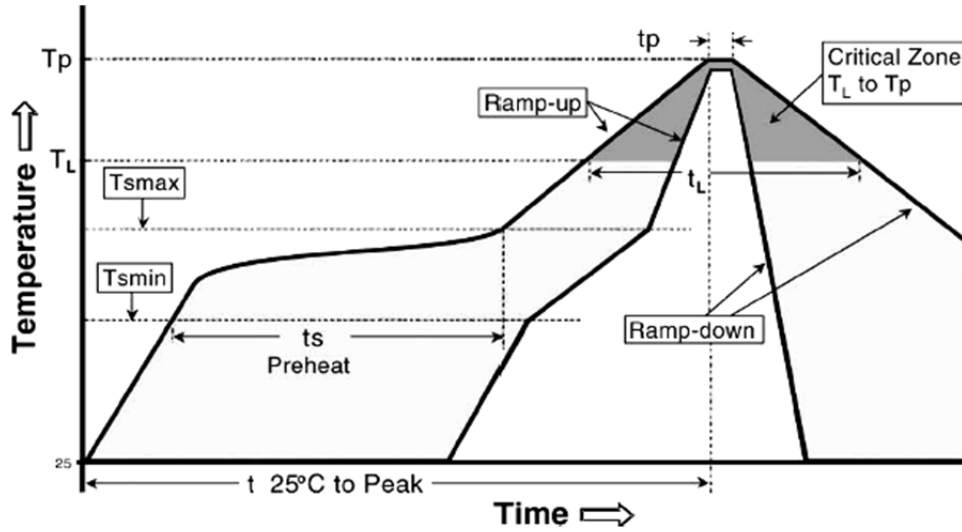

Profile Feature	Lead (Pb)-Free solder
Preheat: Temperature Min (T_{smin}) Temperature Max (T_{smax}) Time (T_{smin} to T_{smax}) (t_s)	150°C 200°C 60 -120seconds
Average ramp-up rate: (T_{smax} to T_p)	3°C/ second max.
Time maintained above : Temperature (T_L) Time (t_L)	217°C 60-150 seconds
Peak Temperature (T_p)	260°C
Time within $\pm 5^\circ C$ of actual peak Temperature (t_p) ²	10 seconds
Ramp-down Rate	6°C/second max.
Time 25°C to Peak Temperature	8minutes max.

Allowed Re-flow times : 2 times

Remark : To avoid discoloration phenomena of chip on terminal electrodes, we suggest N₂ Re-flow furnace .

9.2 Recommend Wave Soldering Profile : (Apply to 0603 and above size)

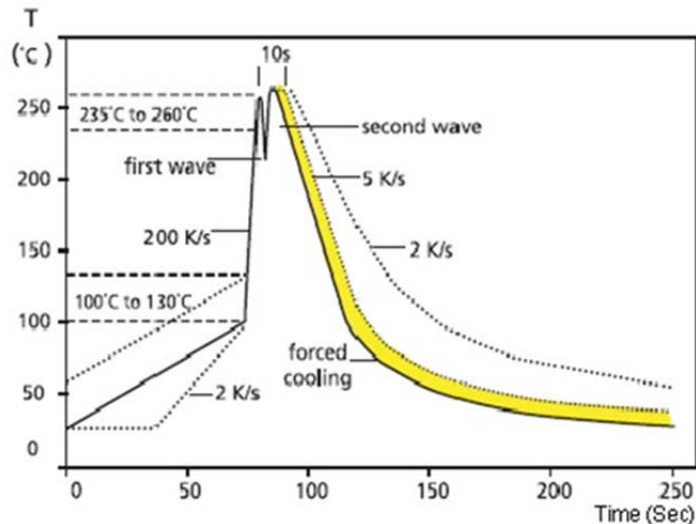

9.3 Recommend land pattern

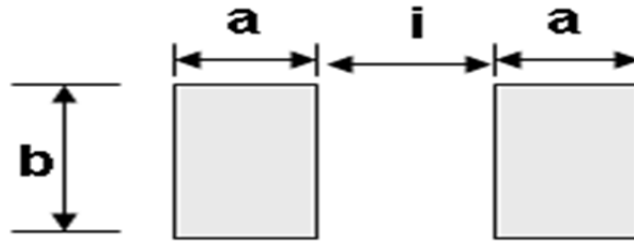

Unit: mm

Type	Resistance Range	a	b	i
LR06	2~30mΩ	1.78	1.93	1.55
LR12	1mΩ~2mΩ	3.20	3.68	1.30
LR12	3mΩ~350mΩ	2.30	3.68	3.15

10. Packing

10.1 Embossed Dimensions:(Unit: mm)

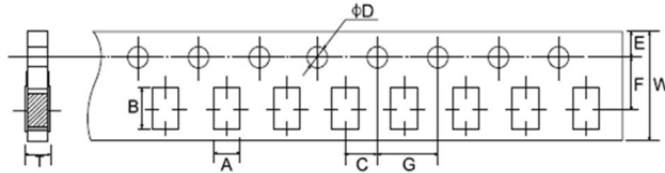

Type	A	B	C	ΦD	E	F	G	W	T
LR06	2.0±0.20	3.6±0.20	2.0±0.05	1.50 ^{+0.1} ₀	1.75±0.10	3.5±0.05	4.0±0.10	8.0±0.20	0.81±0.10

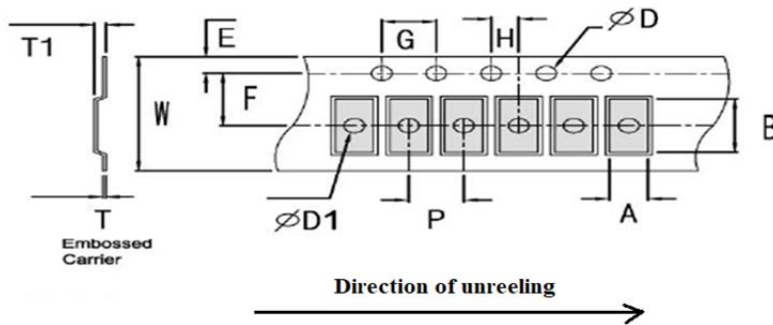

Type	W	P	E	F	ΦD	ΦD1	G	H	A	B	T1	T
LR12	12.0±0.30	4.0±0.10	1.75±0.10	5.5±0.10	1.50 ^{+0.1} ₀	1.55±0.10	4.0±0.10	2.0±0.10	3.50±0.10	6.80±0.10	1.10±0.10	0.20±0.05

10.2 Dimension of Reel : (Unit: mm)

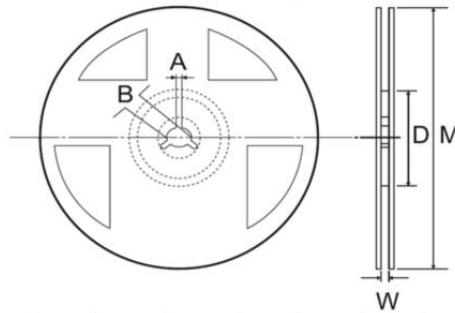

Type	Taping	Qty/Reel	A	B	D	W	ΦM
LR06	Paper	5,000pcs	2.0±0.5	13.0±0.5	60.0±1.0	10.0±1.0	178±2.0
LR12	Embossed	4,000pcs	2.0±0.5	13.0±0.5	60.0±1.0	13.8±1.0	178±2.0

11. Note

- 11.1 UNI-ROYAL recommend products store in warehouse with temperature between 15 to 35°C under humidity between 25 to 75%RH. Even under UNI-ROYAL recommended storage condition, solderability of products over 1 year old. (Put condition for each product) may be degraded.
- 11.2 Store / transport cartons in the correct direction, which is indicated on a carton as a symbol. Otherwise bent leads may occur due to excessive stress applied when dropping of a carton.
- 11.3 Product performance and soldered connections may deteriorate if the products are stored in the following places:
- Storage in high Electrostatic.
 - Storage in direct sunshine、rain and snow or condensation.
 - Where the products are exposed to sea winds or corrosive gases, including Cl₂, H₂S, NH₃, SO₂, NO₂, Br etc.

12. Record

Version	Description	Page	Date	Amended by	Checked by
1	First version	1~7	Apr.09, 2024	Junying Ye	Haiyan Chen
2	1. Modify the dimension 2. Cancel the recommend land pattern	3	May.21, 2024	Junying Ye	Haiyan Chen
3	Add the LR06	1~7	Dec.06, 2024	Haiyan Chen	Yuhua Xu
4	1. Add the ±5% tolerance 2. Add the LR12 1~2m Ω	2~3	Apr.09, 2025	Haiyan Chen	Yuhua Xu
5	Modify Performance Specification	4	Apr.17, 2025	Haiyan Chen	Yuhua Xu

© Uniroyal Electronics Global Co., Ltd. All rights reserved. Specification herein will be changed at any time without prior notice